

Тур 1

ПАЛАТКИ

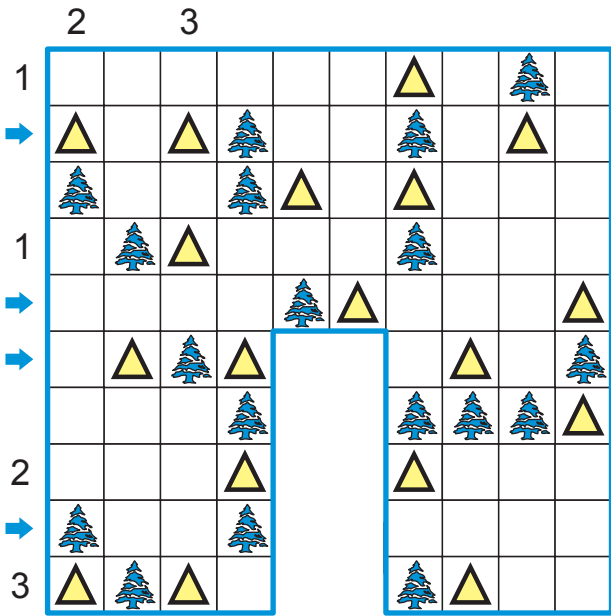

ЗМЕЯ

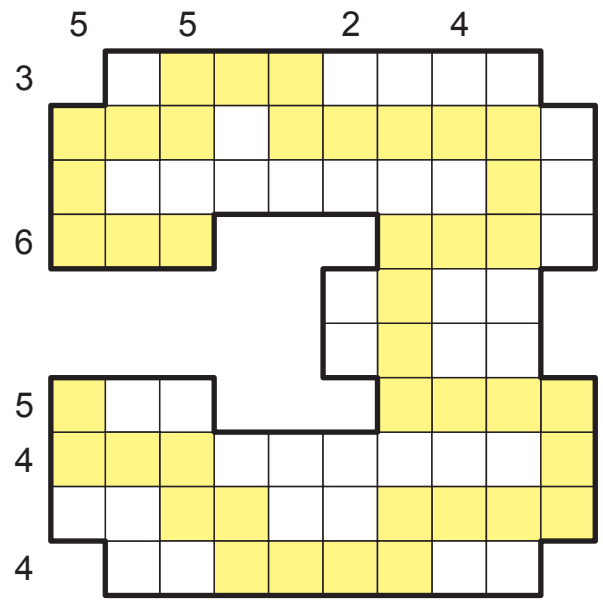

ПЕРЕКРЁСТОК

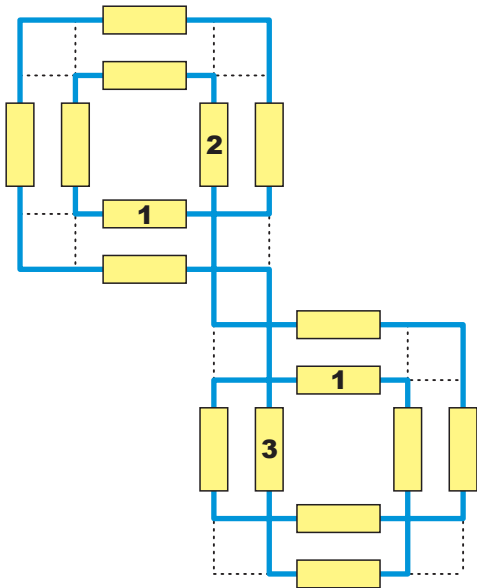

ЗВЁЗДНЫЕ ВОЙНЫ

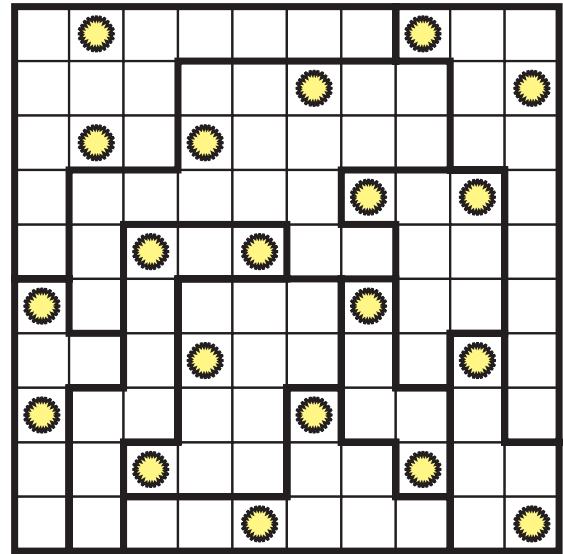

П ИЛИ 3

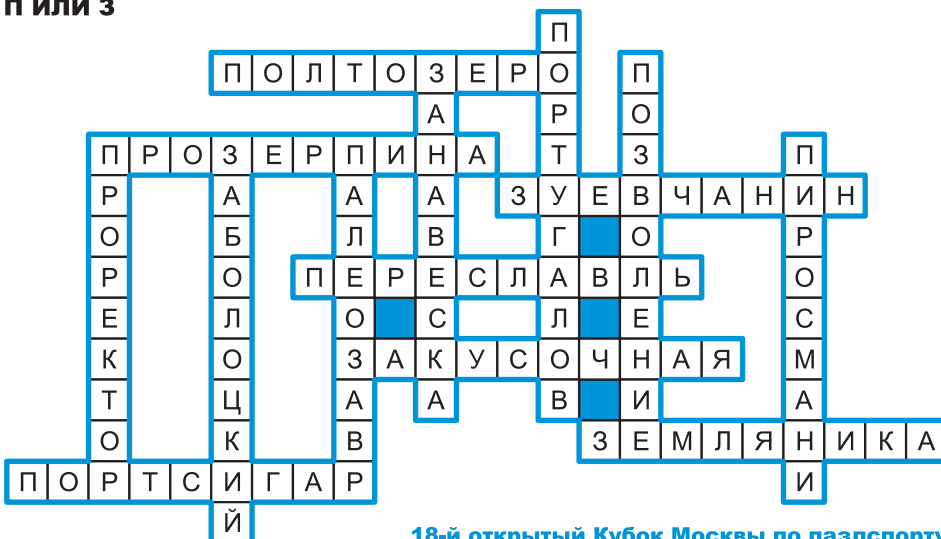

ЗАБОР С ПОЛОВИНКАМИ

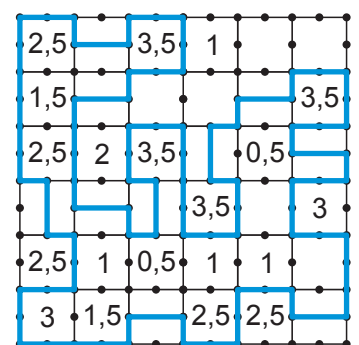

ПЕРВЫЕ ВСТРЕЧНЫЕ С ЗЕРКАЛАМИ

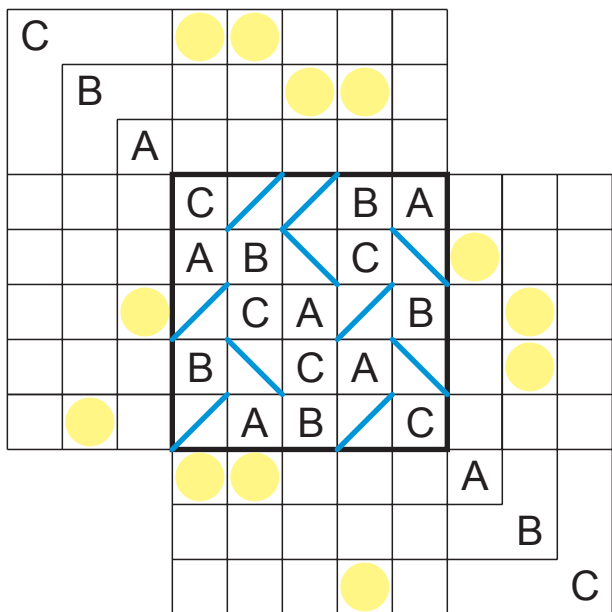

ЗАБОР

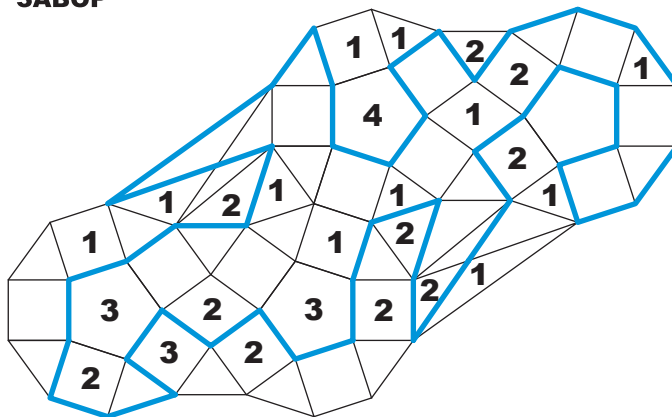

Тур 3

ГЕКСАГОН

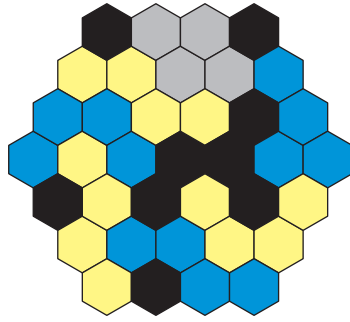
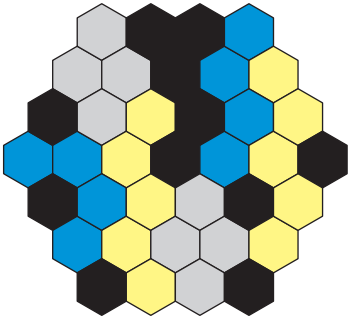

РЫБОЛОВЫ

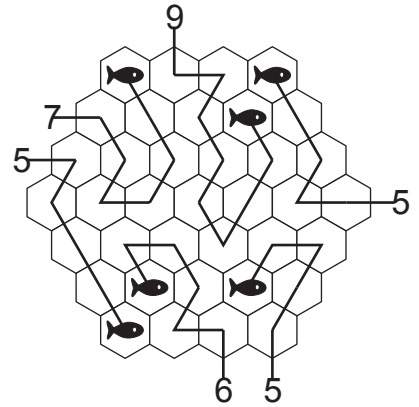

СТРЕЛКИ

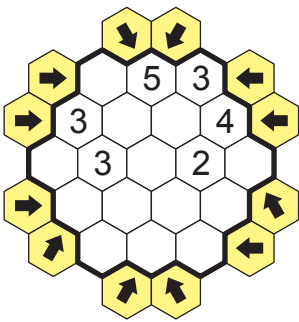

ГЕКСА-СУММЫ

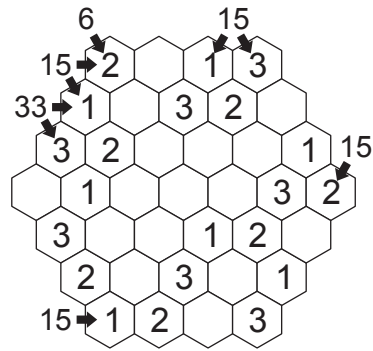

АРИФМЕТИКА

$$\begin{array}{r}
 8 \quad \quad \quad 11 \\
 \text{=} \quad \quad \quad \text{=} \\
 \text{1} + \text{7} - \text{4} = 4 \\
 + \quad - \quad - \\
 9 = \text{3} - \text{2} - \text{6} + \text{8} \\
 - \quad - \quad + \\
 \text{0} + \text{9} - \text{5} = 4 \\
 \text{5} \quad \quad \text{7}
 \end{array}$$

ЗМЕЯ

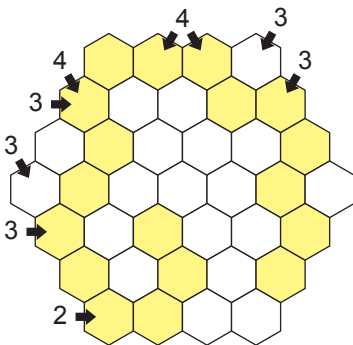

Тур 4

БЕЗДОРОЖЬЕ

? ? 3
? 4 ?

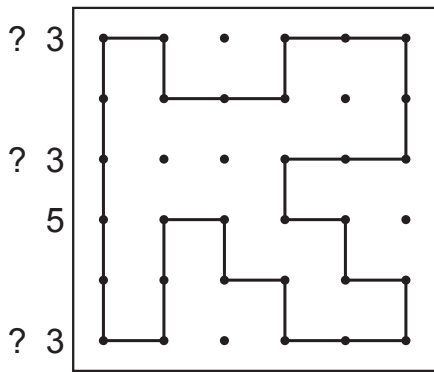

БЕЗ ЗНАКОВ

$$\boxed{6} + \boxed{2} = \boxed{3} = 5$$

+ x

$$\boxed{9} \times \boxed{8} + \boxed{4} = 76$$

+ x

$$\boxed{1} + \boxed{5} \times \boxed{7} = 36$$

|| ||

16 80

$$\boxed{9} \times \boxed{1} \times \boxed{5} = 45$$

x - x

$$\boxed{6} \quad \boxed{7} \quad \boxed{3}$$

- + +

$$\boxed{4} \times \boxed{8} + \boxed{2} = 34$$

|| || ||

50 2 17

БЕЗРЫБЬЕ

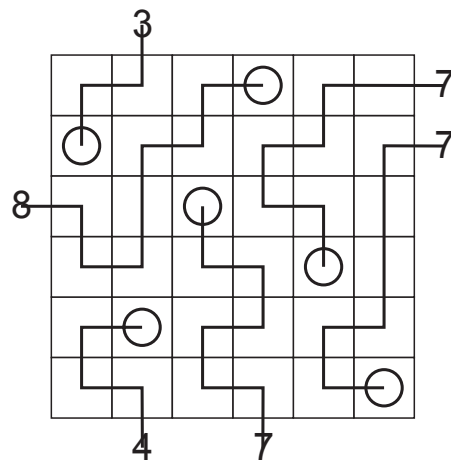

? ?
4 2 1 1 1 ? ? 2
4 ? 1 ? 1 ? ? 3

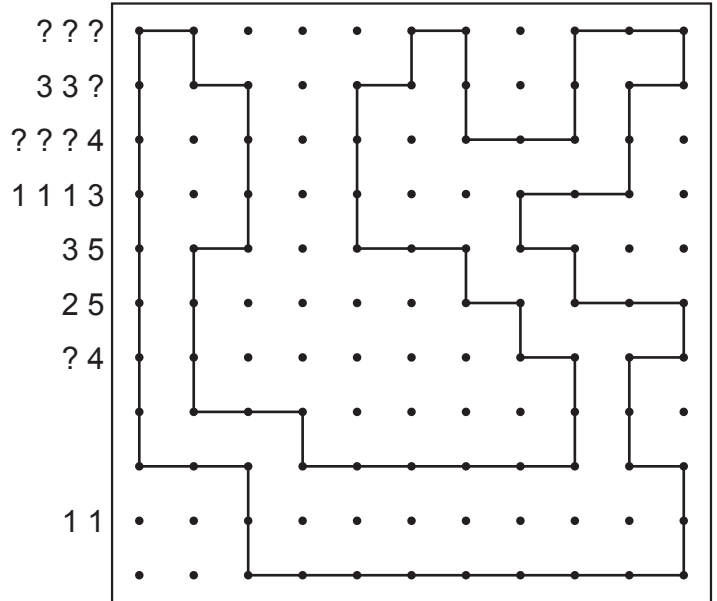

СУДОКУ БЕЗ ОБЛАСТЕЙ

			2	1		
	2	1	2	1	3	
3	3	2	5	6	4	1
2	4	6	1	2	3	5
1	1	1	1	1	1	1
1	1	1	1	1	1	1
4	5	4	6	3	1	2
1	6	5	4	1	2	3
	2	1	3	5	6	4

СУДОКУ БЕЗ ПЕРЕГОРОДОК

			0	1	1	2
	2	3	5	4	6	1
	1	6	4	3	2	5
	3	1	2	6	5	4
3	4	5	6	1	3	2
3	6	2	1	5	4	3
4	5	4	3	2	1	6

СУДОКУ БЕЗ СУММ

1	6	10	4	3	5	2
4	3	8	5	7	2	6
6	7	1	4	3	5	9
2	6	4	9	5	6	3
4	3	1	2	6	5	
5	2	6	1	4	3	

Тип 5

КОРОБКА С АССОРТИ

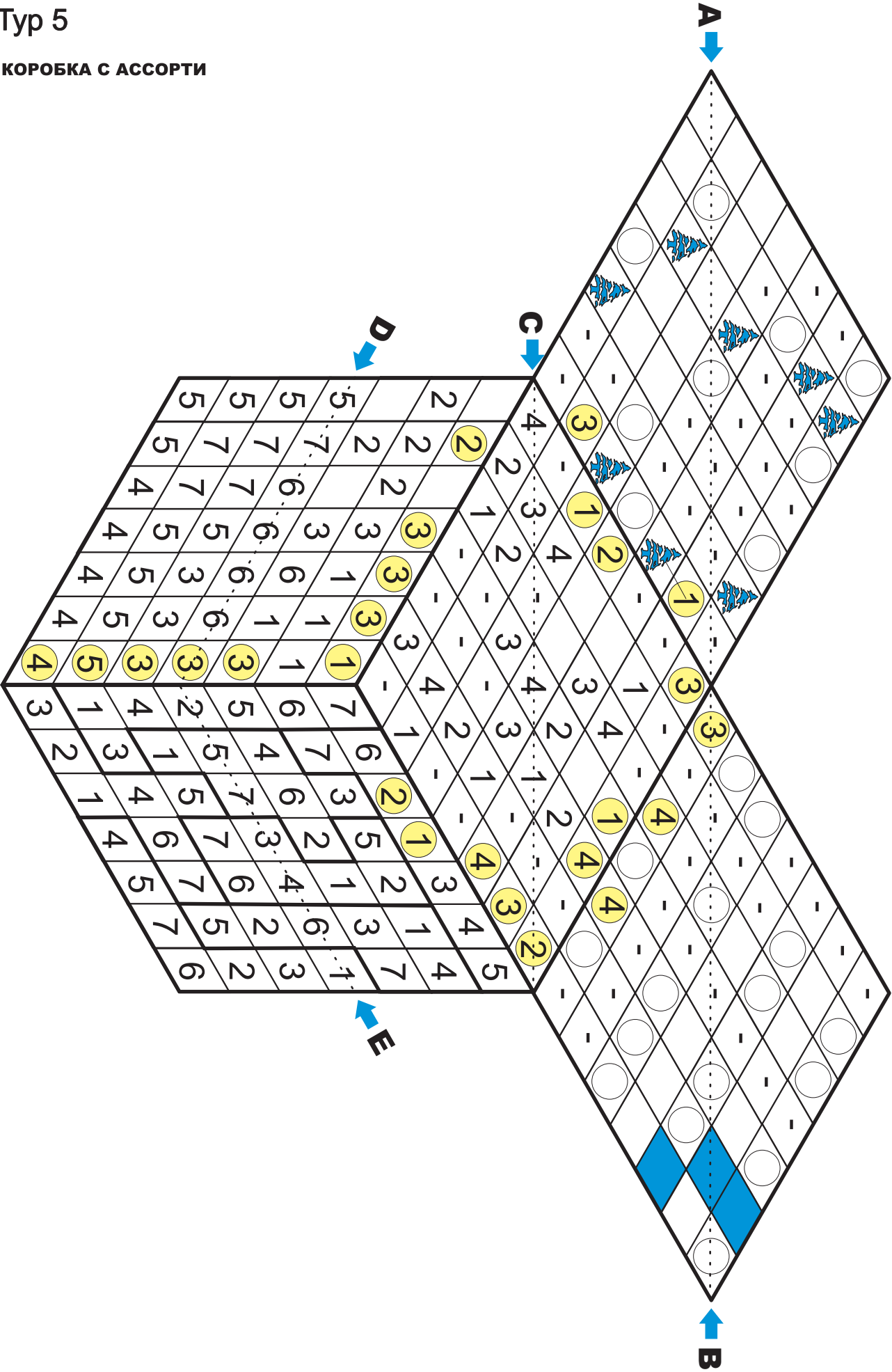

Финал

МОРСКОЙ БОЙ

	4		4		4		4	
4	1		2	2			1	
4	3		1		4	3	2	
4	3		2		4	3	2	
4	3		2		4	3		
4			2		4	3	1	

ПАЛАТКИ

		2						2	
2	⊙		🌲	⊙					
	🌲				🌲	⊙	🌲	⊙	
2			⊙				🌲	🌲	⊙
2	🌲	⊙		🌲			⊙		
			⊙						
2			🌲	🌲	⊙			⊙	🌲
2	⊙	🌲	⊙						
2	🌲				🌲	⊙		⊙	🌲
		🌲		⊙	🌲		🌲		
	⊙				⊙	🌲	⊙	🌲	⊙

СУДОКУ-НЕБОСКРЁБЫ

		5			5	5	
	7	3	6	4	5	2	1
	5	1	7	2	6	4	3
5	1	2	3	6	7	5	4
	2	4	5	7	3	1	6
	3	5	4	1	2	6	7
	4	6	2	3	1	7	5
	6	7	1	5	4	3	2
							5

БЕЗРЫБЬЕ

СТРЕЛКИ
